



NORWEST

MANUFACTURING

71 SOUTH 215 WEST-RUPERT, ID- PHONE: (208) 436-1770 - FAX: (208) 436-1776

SECTION 100

TILLAGE

COTTON & 12 SERIES SWEEPS



CHISEL PLOW & PENETRATOR SWEEPS



PEANUT SWEEPS



FIELD CULTIVATOR SWEEPS



DANISH "S" TINE POINTS & SWEEPS



ALABAMA SWEEPS & WYOMING SHOVELS



FURROWERS



CHISEL POINTS & BULL TONGUES



VEGETABLE KNIVES



INJECTOR KNIVES



IRRIGATION SHOVELS



VIPER SWEEPS





NORWEST

MANUFACTURING

71 SOUTH 215 WEST-RUPERT, ID- PHONE: (208) 436-1770 - FAX: (208) 436-1776

COTTON SWEEPS (JOYCE PATTERN)

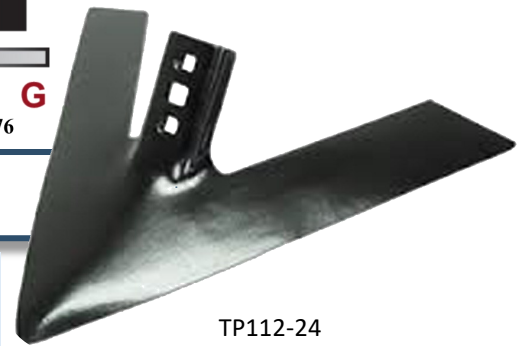

TP112-24

HOLE PATTERNS

Two 7/16" plow bolt holes on 2-1/4" centers & 1 center hole for 5/8" carriage bolt.

STEM

TYPE: Wrap Around
ANGLE: 55°

CROWN

Medium

WING TYPE

Extra Wide

DOMESTIC PART #	IMPORT / TATU PART #	SIZE	WEIGHT EACH (Approx.)	MEAS. (A)
TP112-06	TIP112-06	1/4" X 6"	2.71 LBS.	6"
TP112-08	TIP112-08	1/4" X 8"	3.12 LBS.	8"
TP112-10	TIP112-10	1/4" X 10"	2.94 LBS.	10"
TP112-12	TIP112-12	1/4" X 12"	3.52 LBS.	12"
TP112-14	TIP112-14	1/4" X 14"	4.38 LBS.	14"
TP112-16	TIP112-16	1/4" X 16"	5.74 LBS.	16"
TP112-18	TIP112-18	1/4" X 18"	6.24 LBS.	18"
TP112-20	TIP112-20	1/4" X 20"	8.41 LBS.	20"
TP112-22	TIP112-22	1/4" X 22"	9.08 LBS.	22"
TP112-24	TIP112-24	1/4" X 24"	9.81 LBS.	24"



TP12-28

12 SERIES FLANGE STEM CULTIVATOR SWEEPS

HOLE PATTERNS

Two 7/16" plow bolt holes on 2" centers & 1 center hole for 5/8" carriage bolt.

STEM

TYPE: Wrap Around
ANGLE: 55°

CROWN

Medium

WING TYPE

Medium Wide

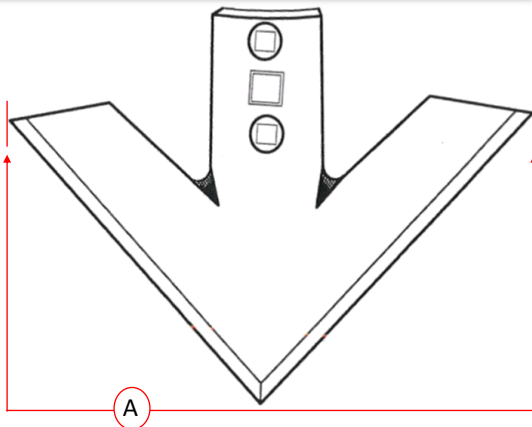

DOMESTIC PART #	SIZE	WEIGHT EACH (Approx.)	MEAS. (A)
TP12-04	1/4" X 4"	1.44 LBS.	4"
TP12-06	1/4" X 6"	1.92 LBS.	6"
TP12-08	1/4" X 8"	2.23 LBS.	8"
TP12-10	1/4" X 10"	2.88 LBS.	10"
TP12-12	1/4" X 12"	3.32 LBS.	12"
TP12-14	1/4" X 14"	4.16 LBS.	14"
TP12-16	1/4" X 16"	4.74 LBS.	16"
TP12-18	1/4" X 18"	4.82 LBS.	18"
TP12-20	1/4" X 20"	5.40 LBS.	20"
TP12-22	1/4" X 22"	5.80 LBS.	22"
TP12-24	1/4" X 24"	6.00 LBS.	24"
TP12-26	1/4" X 26"	7.90 LBS.	26"
TP12-28	1/4" X 28"	7.30 LBS.	28"
TP12-30	1/4" X 30"	8.50 LBS.	30"

Sweeps may be ordered **PLAIN, CHROME, or HARDFACED**

Not all styles in stock. Call Norwest Mfg. for pricing and availability.



NORWEST

MANUFACTURING

71 SOUTH 215 WEST-RUPERT, ID- PHONE: (208) 436-1770 - FAX: (208) 436-1776



TPSW50-185

CHISEL PLOW SWEEPS

HOLE PATTERNS

Two 9/16" plow bolt holes for 1/2" bolts on 2-1/4" centers.

STEM

TYPE: N/A
ANGLE: 50°

CROWN

Medium

WING TYPE

Extra Wide

DOMESTIC PART #	IMPORT / TATU / KELLY PART #	SIZE	WEIGHT EACH (Approx.)	MEAS. (A)
50° SWEEPS • 1/4" MATERIAL				
TPF50-08K	TPSW50-08	1/4" X 8"	4.60 LBS	8"
TPF50-10K	TPSW50-10	1/4" X 10"	5.11 LBS	10"
TPF50-12K	TPSW50-12	1/4" X 12"	5.44 LBS	12"
TPF50-14K	TPSW50-14	1/4" X 14"	6.68 LBS	14"
TPF50-16K	TPSW50-16	1/4" X 16"	7.04 LBS	16"
TPF50-18K	TPSW50-18	1/4" X 18"	8.25 LBS	18"
50° SWEEPS • 5/16" MATERIAL				
TPF50-085K	TPSW50-085	5/16" X 8"	4.90 LBS	8"
TPF50-105K	TPSW50-105	5/16" X 10"	6.10 LBS	10"
TPF50-125K	TPSW50-125	5/16" X 12"	6.63 LBS	12"
TPF50-145K	TPSW50-145	5/16" X 14"	7.64 LBS	14"
TPF50-165K	TPSW50-165	5/16" X 16"	8.68 LBS	16"
TPF50-185K	TPSW50-185	5/16" X 18"	9.30 LBS	18"
—	TPSW50-245	5/16" X 24"	12.00 LBS	24"
TPF50-265K	—	5/16" X 26"	12.82 LBS	26"

Sweeps may be ordered **PLAIN**, **CHROME**, or **HARDFACED**

Not all styles in stock.
Call Norwest Mfg. for pricing and availability.

ULTRAWING SWEEPS

PART	PART #	DESCRIPTION	SHANK SIZE	HOLE CENTERS & BOLT HOLE/SIZE	DEGREE° / CROWN	WEIGHT per EA.
	B5014F-2	Sweep for Chisel Plows; 5/16" x 14" PLAIN	2" shank,	two 9/16" holes on 2-1/4" centers; 1/2" Bolt	50° high crown	7.85 Lbs.
	B5016F-2	Sweep for Chisel Plows; 5/16" x 16" PLAIN	2" shank,	two 9/16" holes on 2-1/4" centers; 1/2" Bolt	50° high crown	8.60 Lbs.
	B5018F-2	Sweep for Chisel Plows; 5/16" x 18" PLAIN	2" shank,	two 9/16" holes on 2-1/4" centers; 1/2" Bolt	50° high crown	8.90 Lbs.



TPSW50-085



TPF50-14K

PENETRATOR SWEEPS

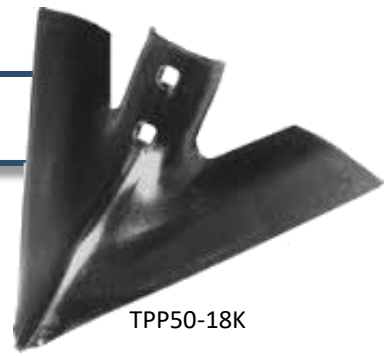

TPP50-18K

HOLE PATTERNS

Two 9/16" plow bolt holes for 1/2" bolts on 2-1/4" centers .

STEM

TYPE: N/A
ANGLE: 50°

CROWN

Medium

WING TYPE

Extra Wide

PART #	SIZE	WEIGHT EACH (Approx.)	MEAS. (A)	PART #	SIZE	WEIGHT EACH	MEAS. (A)
50° SWEEPS • 1/4" MATERIAL				50° SWEEPS • 5/16" MATERIAL			
TPP50-06K	1/4" X 6"	4.59 LBS.	6"	TPP50-065K	5/16" X 6"	4.60 LBS.	6"
TPP50-08K	1/4" X 8"	5.18 LBS.	8"	TPP50-085K	5/16" X 8"	4.60 LBS.	8"
TPP50-10K	1/4" X 10"	5.44 LBS.	10"	TPP50-105K	5/16" X 10"	6.63 LBS.	10"
TPP50-12K	1/4" X 12"	6.68 LBS.	12"	TPP50-125K	5/16" X 12"	6.63 LBS.	12"
TPP50-14K	1/4" X 14"	7.04 LBS.	14"	TPP50-145K	5/16" X 14"	7.64 LBS.	14"
TPP50-16K	1/4" X 16"	7.04 LBS.	16"	TPP50-165K	5/16" X 16"	8.68 LBS.	16"
TPP50-18K	1/4" X 18"	8.25 LBS.	18"	TPP50-185K	5/16" X 18"	9.30 LBS.	18"
TPP50-22K	1/4" X 22"	10.20 LBS.	22"				

***Larger sweeps are available.
Call Norwest Mfg. for more information.*



Z-GPP50-16K

DEEP TILL FUMIGANT APPLICATION

HOLE PATTERNS

Two 9/16" plow bolt holes for 1/2" bolts on 2-1/4" centers .

W/POCKET: Two 13/16" slots for 1/2" bolts on 2-1/2" centers

STEM

TYPE: N/A
ANGLE: 50°

CROWN

Medium

WING TYPE

Extra Wide

DOMESTIC PART #	APPLICATION	SIZE	WEIGHT EACH (Approx.)	MEAS. (A)
CHROME				
Z-GPP50-125NP* <i>No Pocket</i>	FOR GREAT PLAINS RIPPER	5/16" X 12"	8.13 LBS.	12"
Z-GPP50-145NP* <i>No Pocket</i>	FOR GREAT PLAINS RIPPER	5/16" X 14"	9.10 LBS.	14"
Z-GPP50-16K* <i>With Pocket</i>	FOR GREAT PLAINS RIPPER <i>1-1/4" POCKET</i>	1/4" X 16"	11.90 LBS.	16"
Z-GPP50-165K* <i>With Pocket</i>	FOR GREAT PLAINS RIPPER <i>1-1/4" POCKET</i>	5/16" X 16"	13.31 LBS.	16"
Z-GPP50-16NP* <i>No Pocket</i>	FOR GREAT PLAINS CHISEL PLOW	1/4" X 16"	10.00 LBS.	16"
Z-GPP50-165NP* <i>No Pocket</i>	FOR GREAT PLAINS CHISEL PLOW	5/16" X 16"	11.65 LBS.	16"
Z-JPP50-22K* <i>With Pocket</i>	FOR JOHN DEERE DAMMER-DIKER & JOHN DEERE RIPPER <i>1-1/4" POCKET</i>	1/4" X 22"	15.50 LBS.	22"

**Deep Till Fumigant Applications can be made in various sizes for different applications.
Available for Great Plains, John Deere, Dammer-Diker, and other chisel plows.*

Please call Norwest Mfg. for more details.

Sweeps may be ordered PLAIN, CHROME, or HARDFACED

Not all styles in stock. Call Norwest Mfg. for pricing and availability.



NORWEST

MANUFACTURING

71 SOUTH 215 WEST-RUPERT, ID- PHONE: (208) 436-1770 - FAX: (208) 436-1776



PEANUT SWEEPS

HOLE PATTERNS

1-1/4" - 2-1/4" centers for
7/16" plow bolt

STEM

TYPE: Flanged
ANGLE: 54°

CROWN

Low

WING TYPE

Extra Wide



TIP132-18



TIP131-06



IMPORT / TATU PART #		SIZE	WEIGHT EACH (Approx.)	MEAS. (A)
54° SWEEPS •				
3/16" & 1/4"				
MATERIAL				
TIP131-06	TIH131-06	TIC131-06	3/16" X 6"	1.20 LBS 6"
TIP131-08	TIH131-08	TIC131-08	3/16" X 8"	1.30 LBS 8"
TIP131-10	TIH131-10	TIC131-10	3/16" X 10"	1.83 LBS 10"
TIP131-12	TIH131-12	TIC131-12	3/16" X 12"	2.16 LBS 12"
TIP132-14	TIH132-14	TIC132-14	1/4" X 14"	3.00 LBS 14"
TIP132-16	TIH132-16	TIC132-16	1/4" X 16"	3.58 LBS 16"
TIP132-18	TIH132-18	TIC132-18	1/4" X 18"	3.73 LBS 18"

*Sweeps may be ordered **PLAIN, CHROME, or HARDFACED***

CREASER POINTS

*Not all styles in stock.
Call Norwest Mfg. for pricing and availability.*

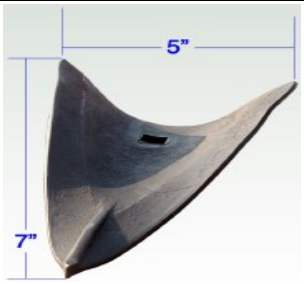

PART	PART #	DESCRIPTION	BOLT HOLE / BOLT SIZE
	CREASER-1	5" X 7" X 5/16" SQUARE POINT	9/16" SQUARE HOLE FOR 1/2" PLOW BOLT
	CREASER-3	5-1/2" X 7" X 5/16" ROUND POINT	9/16" SQUARE HOLE FOR 1/2" PLOW BOLT

VIPER SWEEPS

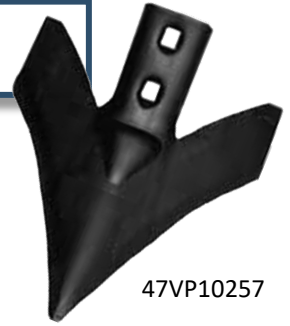

47VP10257

HOLE PATTERNS

Two 1/2" bolt holes for 7/16" plow bolts on 1-3/4" centers.

TYPE: Wrap Around

ANGLE: 47°

CROWN

Low

WING TYPE

Stay Wide/Ultra Wing

STEM

<u>IMPORT / TATU</u> PART #	SIZE	WEIGHT EACH (Approx.)	MEAS.
TIP47V0457	7.5MM X 4.25"	2.81 LBS.	4.25"
TIP47V0657	7.5 MM X 6.25"	2.92 LBS.	6.25"
TIP47V0757	7.5 MM X 7.25"	3.31 LBS.	7.25"
TIP47V0857	7.5 MM X 8.25"	3.66 LBS.	8.25"
TIP47V0957	7.5 MM X 9.25"	3.84 LBS.	9.25"
TIP47V1057	7.5 MM X 10.25"	4.25 LBS.	10.25"
TIP47V1257	7.5 MM X 12.25"	5.55 LBS.	12.25"



TIP47V0757

FIELD CULTIVATOR SWEEPS



TP202-104

HOLE PATTERNS

Two 1/2" bolt holes for 7/16" plow bolts on 1-5/8" - 1-3/4" centers.

TYPE: Wrap Around

ANGLE: 47°

CROWN

Low

WING TYPE

Long wearing parallel wing

STEM

<u>DOMESTIC</u> PART #	<u>IMPORT / TATU</u> PART #	SIZE	WEIGHT EACH (Approx.)	MEAS. (A)
47° SWEEPS • 1/4" MATERIAL				
TP202-044	TIP202-044	1/4" X 4"	1.59 LBS	4"
TP202-064	TIP202-064	1/4" X 6"	1.88 LBS	6"
TP202-074	TIP202-074	1/4" X 7"	2.32 LBS	7"
TP202-084	TIP202-084	1/4" X 8"	2.33 LBS	8"
TP202-094	TIP202-094	1/4" X 9"	2.60 LBS	9"
TP202-104	TIP202-104	1/4" X 10"	3.10 LBS	10"
TP202-114	—	1/4" X 11"	3.20 LBS	11"
TP202-124	TIP202-124	1/4" X 12"	3.43 LBS	12"
47° SWEEPS • 5/16" MATERIAL				
TP202-075	—	5/16" X 7"	2.85	7"
TP202-095	—	5/16" X 9"	3.50	9"
TP202-105	—	5/16" X 10"	3.96	10"

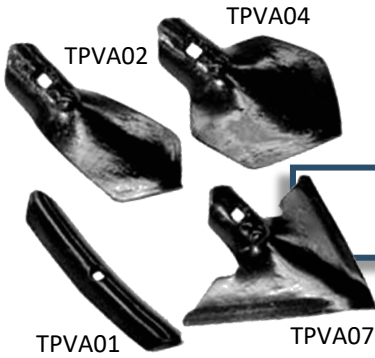

DANISH "S" TINE SWEEPS & POINTS

HOLE PATTERNS

Single 3/8" plow bolt hole

CROWN

Low

WING TYPE

Long Wear

PART #			SIZE	MEAS. (A)	MEAS. (B)
PLAIN	HARDFACED	TUFF KOAT®			
TPVA01	THVA01	TDVA01	1/4" X 1"	8" POINT	1-5/8"
TPVA15	THVA15	TDVA15	1/4" X 1-1/2"	8-1/2" POINT	1-3/4"
TPVA25	—	—	1/4" X 2"	10" POINT	2"
TPVA02	THVA02	TDVA02	1/4" X 2-3/4"	N/A	2-3/4" GOOSE FOOT
TPVA04	THVA04	TDVA04	1/4" X 4"	N/A	4" GOOSE FOOT
TPVA44	THVA44	TDVA44	1/4" X 4"	N/A	4" WINGED
TPVA07	THVA07	TDVA07	1/4" X 7"	N/A	7" WINGED
TPVA09	THVA09	TDVA09	1/4" X 9"	N/A	9" WINGED
TPVA10	THVA10	—	1/4" X 10"	N/A	10" WINGED
SOLID CHROME SWEEPS & POINT			(includes: SHIM, BOLT, and NUT)		
CVS-01M			SOLID CHROME	6" POINT	1"
CVS-02M			SOLID CHROME	N/A	2-3/4" GOOSE FOOT
CVS-04M			SOLID CHROME	N/A	4" GOOSE FOOT
CVS-07M			SOLID CHROME	N/A	7" WINGED

NORWEST MANUFACTURING
71 South 215 West - Ripert, IA 83350 • Ph: (208) 436-1770 • Fax: (208) 436-1776

TATU MARCHESAN

SNAP ON CULTIVATOR SWEEPS				
PART	NORWEST PART NUMBER	DIMENSIONS	ANGLE	WEIGHT (LBS.)
	TIPSNAP02	2" x 7.5mm	47°	1.68
	TIPSNAP04	4" x 7.5mm	47°	2.13
	TIPSNAP06	6" x 7.5mm	47°	2.51
	TIPSNAP08	8" x 7.5mm	47°	2.99
	TIPSNAP09	9" x 7.5mm	47°	3.23
	TIPSNAP10	10" x 7.5mm	47°	3.44
	TIPSNAP12	12" x 7.5mm	47°	3.95
ADAPTORS FOR SNAP ON CULTIVATOR SWEEPS				
PART	NORWEST PART NUMBER	HOLE SPECS.	ANGLE	WEIGHT (LBS.)
	TIPSNAP47	(2) 1/2" Plow Head Bolt; 1-3/4" Centers	47°	0.92
	TIPSNAP50	(2) 1/2" Plow Head Bolt; 2-3/4" Centers	50°	1.32

STAYWIDE®

-VS-

REGULAR WING

ELLIPTICAL HEAD BOLTS for <u>NON-CHROME</u> DANISH APPLICATIONS		
	PART #	DESCRIPTION
	SB3858	Danish 3/8" x 1-1/2" Elliptical Head Bolt w/ Nut
	SB3878	Danish 3/8" x 1-3/4" Elliptical Head Bolt w/ Nut

Sweeps may be ordered :

PLAIN • HARDFACED • TUFF KOAT® (NOT AVAILABLE ON SOLID CHROME SWEEPS)

◇ Chrome Danish Sweeps & Point Inset Below ◇



REVERSIBLE DANISH POINT	GOOSE FOOT SWEEP	4" GOOSE FOOT SWEEP	WINGED DANISH SWEEP



NORWEST

MANUFACTURING

71 SOUTH 215 WEST-RUPERT, ID- PHONE: (208) 436-1770 - FAX: (208) 436-1776



TPE47-16

ALABAMA SWEEPS (solid)

HOLE PATTERNS

Two 7/16" plow bolt holes on 2-1/4" centers and center hole for 5/8" carriage bolt.

STEM

TYPE: Solid
ANGLE: N/A

CROWN

Low

WING TYPE

None: solid

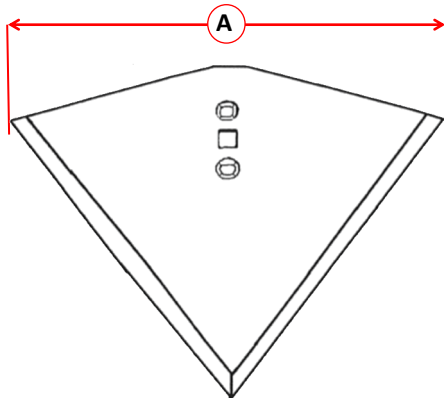

PART #	SIZE	WEIGHT EACH (Approx.)	MEASUREMENT
TPE47-08	1/4" X 8"	1.95 LBS.	8"
TPE47-10	1/4" X 10"	2.35 LBS.	10"
TPE47-12	1/4" X 12"	3.35 LBS.	12"
TPE47-14	1/4" X 14"	4.40 LBS.	14"
TPE47-16	1/4" X 16"	5.95 LBS.	16"
TPE47-18	1/4" X 18"	8.10 LBS.	18"
TPE47-20	1/4" X 20"	9.00 LBS.	20"
TPE47-22	1/4" X 22"	10.25 LBS.	22"
TPE47-24	1/4" X 24"	11.10 LBS.	24"

Sweeps may be ordered:

PLAIN • HARDFACED • CHROME



TPS1028

IRRIGATION SHOVELS

HOLE PATTERNS

One hole for a 3/8" carriage bolt.

CORN SHOVEL HOLE PATTERN:

Two 1/2" bolt holes for 3/8" plow bolts on 2" centers, and a center hole for a 3/4" carriage bolt.

CROWN

N/A

WING TYPE

N/A

PART #	MATERIAL	SIZE	WEIGHT EACH (Approx.)	MEAS. (A)
TPS1028	3/16"	3/16" X 8"	4.90 LBS.	8"

****Shovels not available with chrome.**

Not all styles in stock.
Call Norwest Mfg. for pricing and availability.

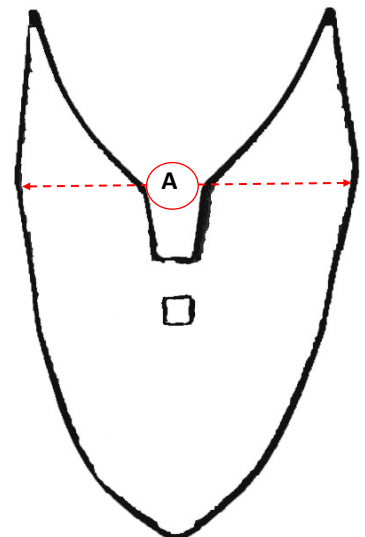

◇◇◇

To obtain the correct measurement for (A), measure the width from tip to tip at the bottom of the wings on the back side of the shovel.

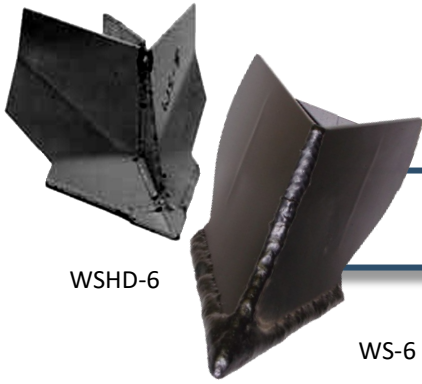

NORWEST

MANUFACTURING

71 SOUTH 215 WEST-RUPERT, ID- PHONE: (208) 436-1770 - FAX: (208) 436-1776



WYOMING SHOVELS

HOLE PATTERNS

Single 3/8" plow bolt

hole

CROWN

Low

WING TYPE

NORWEST PART #	STANDARD SIZE	WEIGHT EACH (Approx.)	MEAS. (A)	NORWEST PART #	STANDARD SIZE	WEIGHT EACH (Approx.)	MEAS. (A)
Wyoming Shovel with Hardfacing				Heavy Duty Wyoming Shovel with Hardfacing & Chrome Tip			
WS-4	5/8" X 1-1/2" X 2"	6.58 LBS.	4"	WSHD-6	ALL SIZES	8.30 LBS.	6"
WS-6	5/8" X 1-1/2" X 2"	6.80 LBS.	6"				
WS-8	3/4" X 2" X 2-1/2"	10.80 LBS.	8"	WSHD-08	ALL SIZES	13.08 LBS.	8"
WS-10	3/4" X 2" X 2-1/2"	16.56 LBS.	10"				

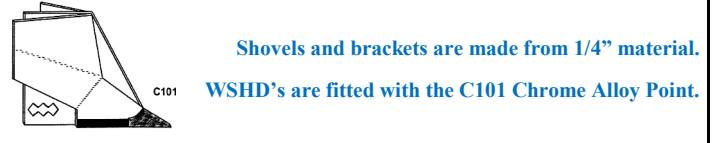
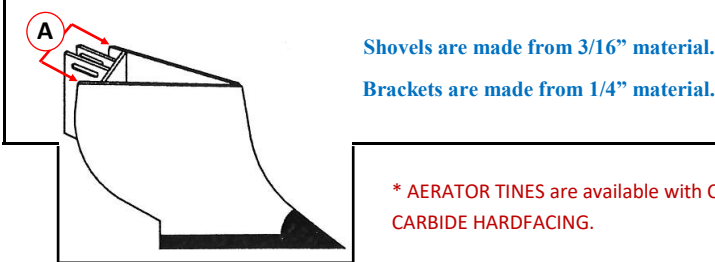

* AERATOR TINES are available with CHROMIUM CARBIDE HARDFACING.

AERATOR TINES

MATERIAL THICKNESS:

A: 1"	B: 1" TO 1/4"	C: 5/8" TO 1/4"
--------------	----------------------	------------------------

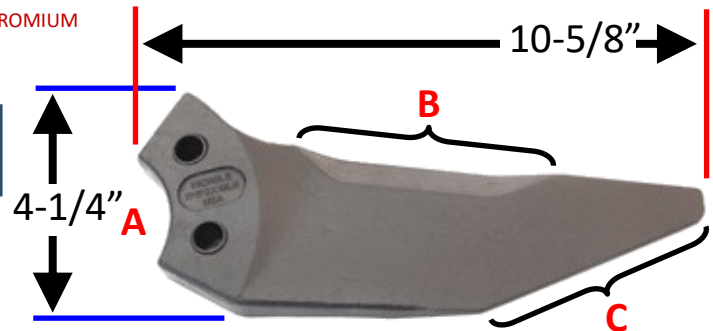

PART	PART NUMBER	DESCRIPTION	HOLE SIZE	WEIGHT
	RHP3X10R	AERATOR HARROW TINE; RIGHT HAND	(2) 1/2" BOLT HOLES FOR 7/16" BOLTS	5.16 LBS. EACH
	RHP3X10L	AERATOR HARROW TINE; LEFT HAND		

Not all styles in stock. Call Norwest Mfg. for pricing and availability.

www.norwest-mfg.com

Tillage 100-9



NORWEST

MANUFACTURING

71 SOUTH 215 WEST-RUPERT, ID- PHONE: (208) 436-1770 - FAX: (208) 436-1776



TP3235

HIGH WING FURROWERS

HOLE PATTERNS

Two holes, on 2-1/4" centers for 7/16" plow bolts and 1 square hole for 5/8" carriage bolt.

CROWN

Medium

WING TYPE

High Wing

DOMESTIC PART #		SIZE	WEIGHT EACH (Approx.)	MEAS. (A)	MEAS. (B)
PLAIN	HARDFACED		PLAIN		BACK SIDE
1/4" MATERIAL					
TP3235	TH3235	1/4" X 8"	8.25 LBS.	8"	8-1/4"
TP3236	TH3236	1/4" X 10"	8.55 LBS.	10"	8-1/8"
TP3237	TH3237	1/4" X 12"	10.85 LBS.	12"	9-1/4"
TP3238	TH3238	1/4" X 15"	13.25 LBS.	15"	10-7/8"
TP3239	TH3239	1/4" X 18"	15.85 LBS.	18"	12"

HIGH WING FURROWER

NORWEST PART#
TP3235

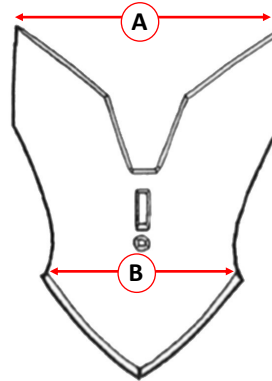
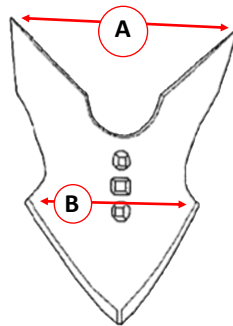

HEAVY DUTY FURROWER
NORWEST PART#

HEAVY DUTY FURROWERS

HOLE PATTERNS

Two holes, one slotted, for 1-1/4" to 2-1/4" centers for 7/16" plow bolt

STEM

TYPE: N/A
ANGLE: N/A

CROWN

High

WING TYPE

High Wing



TPH112UB

PART #	SIZE	WEIGHT EACH (Approx.)	MEAS. (A)	MEAS. (B)
BACK SIDE				
TPH1110UB	1/4" X 10"	10.40 LBS.	10"	9-5/8"
TPH1112UB	1/4" X 12"	11.30 LBS.	12"	9-1/2"
TPH1115UB	1/4" X 15"	13.75 LBS.	15"	12-1/16"
TPH1118UB	1/4" X 18"	16.25 LBS.	18"	13-9/16"

Not all styles in stock.
Call Norwest Mfg. for pricing and availability.

Furrowers may be ordered :
PLAIN • HARDFACED



NORWEST

MANUFACTURING

71 SOUTH 215 WEST-RUPERT, ID- PHONE: (208) 436-1770 - FAX: (208) 436-1776

TILLAGE POINT STYLES

A	B	C	D	E	F	G	H
I	J	K	L	M	N	O	

Select Points may be ordered with the following prefixes:

- TP = PLAIN
- TH = HARDFACED
- TC = CHROME

Not all styles in stock. Call Norwest Mfg. for pricing and availability.

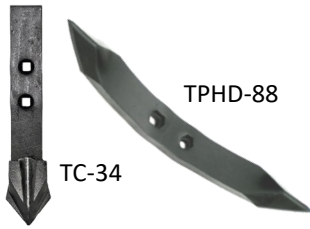

NORWEST

MANUFACTURING

71 SOUTH 215 WEST-RUPERT, ID- PHONE: (208) 436-1770 - FAX: (208) 436-1776



SPRING TOOTH, FIELD CULTIVATOR, REVERSIBLE STEELS & CHISEL POINTS

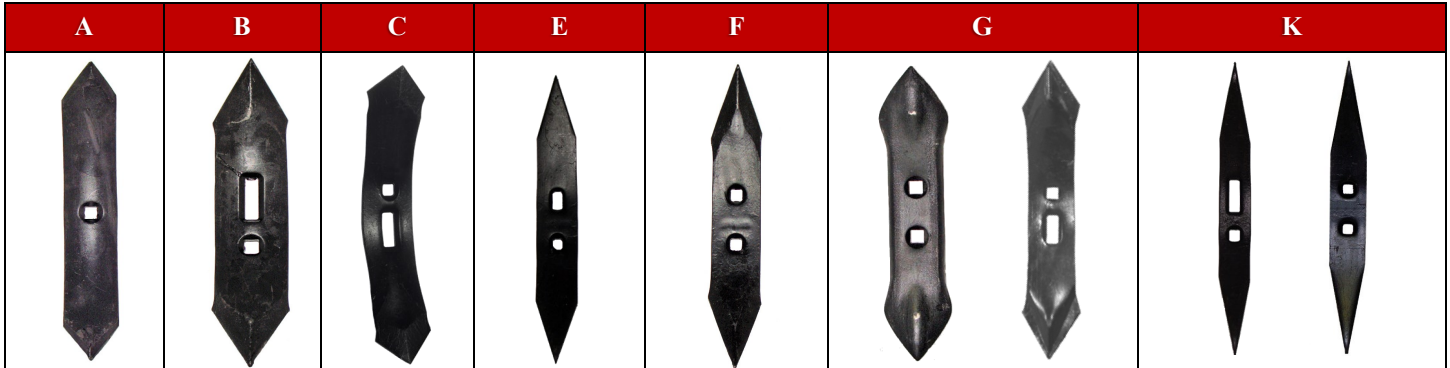

PART #			MATERIAL (A)	WIDTH (B)	LENGTH (C)	HOLE CENTER	BOLT SIZE	WEIGHT EACH (Approx.)	POINT STYLE
PLAIN	HARDFACED	CHROME	See diagram below for Measurements.					PLAIN	
SPRING TOOTH & FIELD CULTIVATOR POINTS									
TPDF-10	THDF-10	—	1/4"	1-3/4"	11"	1-3/4"	3/8"	0.95 LBS.	F
TPDF-10UA	THDF-10UA	—	1/4"	1-3/4"	11"	1-1/4" - 2-1/4"	3/8"	0.95 LBS.	F
TPDF-14	THDF-14	—	1/4"	1-3/4"	11"	1-3/4"	7/16"	0.95 LBS.	F
DP2237	—	—	3/8"	2"	12"	2"	7/16" #3 Plow Bolts	2.35 LBS.	K
CC37	—	—	3/8"	2"	12"	1-5/8" - 1-3/4"	7/16" #3 Plow Bolts	2.35 LBS.	K
DP2276S	—	—	3/8"	2"	11-3/4"	1" - 2"	7/16" #3 Plow Bolts	2.25 LBS.	K
TPDF010	THDF010	TCDF010	1/4"	1-3/4"	11"	1-3/4" - 1-5/8"	3/8"	0.95 LBS.	E
TPIF-10UB	—	—	5/16"	1-1/2"	10"	1-1/4" - 2-1/4"	7/16"	1.12 LBS.	B
TPIF-110UB	THIF-110UB	—	5/16"	2-1/2"	10"	1-1/4" - 2-1/4"	7/16"	1.64 LBS.	B
TPIF-210UB	THIF-210UB	TCIF-210UB	5/16"	2"	10"	1-1/4" - 2-1/4"	7/16"	0.95 LBS.	B
REVERSIBLE STEELS, ALFALFA SPIKES FOR COIL SHANKS & CHISEL PLOWS									
TP169UB	TH169UB	TC169UB	5/8"	2"	12"	1-1/4" - 2-1/4"	7/16"	2.85 LBS.	C
TP75UB	TH75UB	TC75UB	1/2"	1-1/2"	12"	1-1/4" - 2-1/4"	7/16"	1.75 LBS.	G

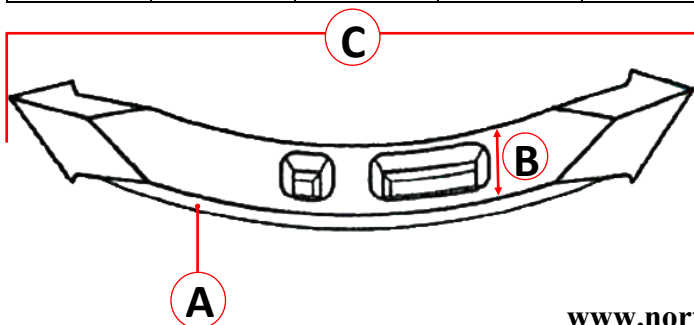

Points may be ordered:
PLAIN • HARDFACED • CHROME

Not all styles in stock.
Call Norwest Mfg. for pricing and availability.



123050

SPRING TOOTH, FIELD CULTIVATOR, REVERSIBLE STEELS & CHISEL POINTS

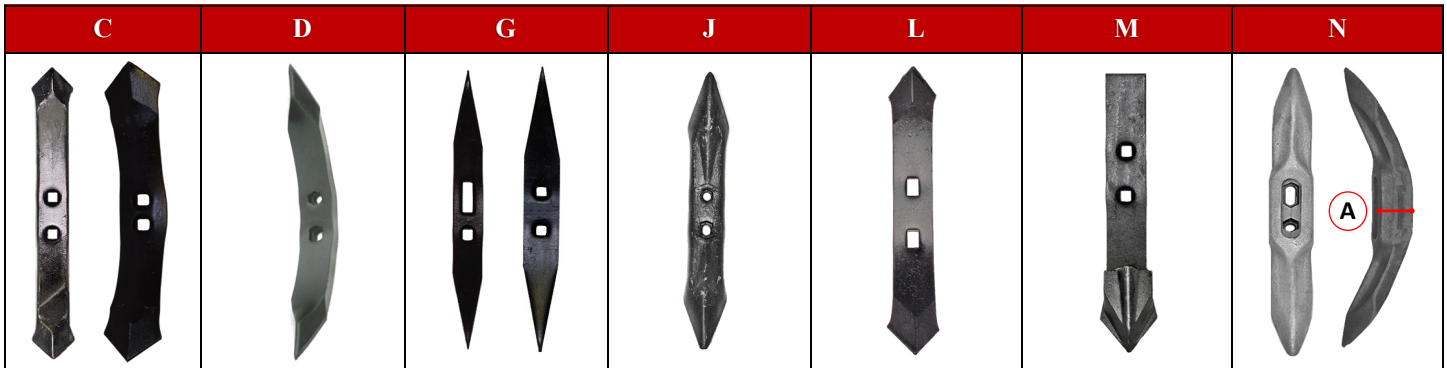

PART #	MATERIAL (A)	WIDTH (B)	LENGTH (C)	HOLE CENTER	BOLT SIZE	WEIGHT EACH (Approx.)	POINT STYLE
Refer to page 100-12 for Measurements.							
CHISEL PLOW POINTS							
123050	5/8"	2"	11-1/2"	1-3/4" - 2-1/2"	1/2"	4.50 LBS.	L
TPN182-9	5/8"	2"	15"	2-1/4"	5/8"	4.90 LBS.	C
TPHC2C8-S	5/8"	2"	16"	2-1/4" - 2-1/2"	1/2"	5.73 LBS.	C
TP21610HC75	3/4"	2"	16"	2-1/4" - 2-1/2"	1/2"	4.80 LBS.	L
TC-10 <i>Single End</i>	1"	2"	12"	2-1/4"	1/2"	5.80 LBS.	M
TPHD-88	1"	2"	17"	2-1/4" - 2-1/2"	1/2"	9.30 LBS.	D
TIPHD-88	1"	2"	18"	2-1/4" - 2-1/2"	1/2"	11.85 LBS.	D
TCHD-88SC	2" SOLID CHROME	2-1/4"	17"	2" - 2-3/4"	1/2"	12.00 LBS.	N
✓ SD-22-5	7/8"	2"	19-1/2"	2-1/4" - 2-1/2"	1/2"	8.00 LBS.	J
✓ SD-23	1-1/4"	2-1/2"	19"	2-1/4" - 2-1/2" <i>Slotted</i>	1/2"	12.00 LBS.	J
C258-5	5/8"	2"	17"	2-1/4"	1/2"	5.00 LBS.	C
R258-5 <i>Will fit I.H.C.</i>	5/8"	2"	17-1/2"	2-1/4"	1/2" #3 Plow Bolts	5.00 LBS.	C

✓ FOR USE ON **HIGH CLEARANCE** SHANKS ONLY

CHISEL PLOW SHANK PROTECTOR

DOMESTIC PART #	MATERIAL (A)	WIDTH (B)	LENGTH (C)	HOLE CENTER	BOLT SIZE	WEIGHT EACH (Approx.)
ULTRA HIGH DENSITY POLY SHANK PROTECTOR FOR CHISEL PLOW SHANKS						
2614120P	1/4"	2-1/8"	10"	1-3/4" - 2-1/2"	1/2"	0.06 LBS.

Poly Shank Protector

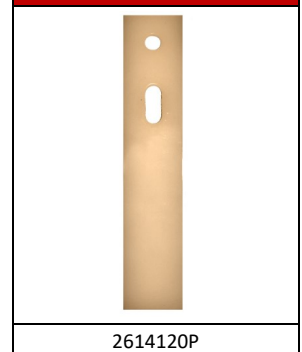

2614120P



NORWEST

MANUFACTURING

71 SOUTH 215 WEST-RUPERT, ID- PHONE: (208) 436-1770 - FAX: (208) 436-1776

123L5

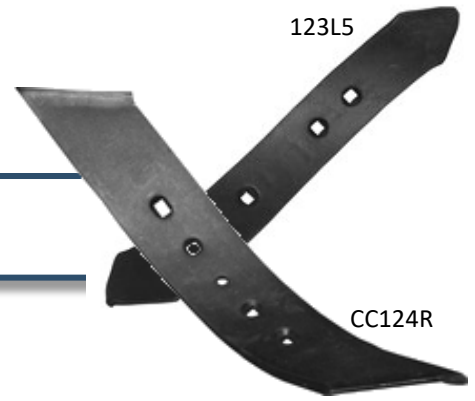

TWISTED CHISEL POINTS

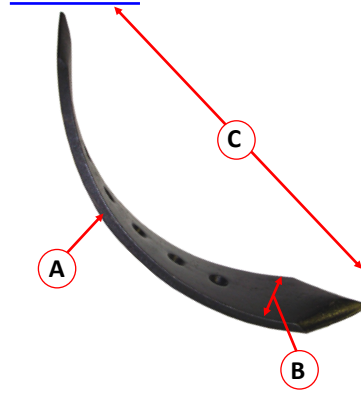
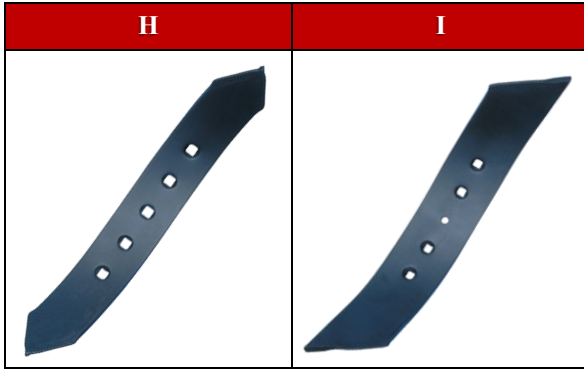

Use #3 Plow Head Bolts
2-1/2" Length
Note: I.H.C. Chisel Plows have a
slotted shank and will accept a
center punching of 2-1/4".

PART #	MATERIAL (A)	WIDTH (B)	LENGTH (C)	HOLE CENTER	BOLT SIZE	WEIGHT EACH (Approx.)	POINT STYLE
123L5 (LEFT)	1/2"	3"	22"	2-1/4"	1/2"	8.50 LBS.	H
123R5 (RIGHT)							
124L-5 (LEFT)	1/2"	4"	22"	2-1/4"	1/2"	11.25 LBS.	H
124R-5 (RIGHT)							
CC124L (LEFT) <i>Slash Point</i>	1/2"	4"	24"	2-1/4" - 2-1/2"	1/2"	12.50 LBS.	I
CC124R (RIGHT) <i>Slash Point</i>							
TPDF5995UCL (LEFT)	1/2"	3"	22"	2-1/4" - 2-1/2"	1/2"	9.00 LBS.	H
TPDF4995UCR (RIGHT)							
TP320-6LKS (LEFT)	3/8"	3"	22"	2-1/4" - 2-1/2"	1/2"	7.85 LBS.	H
TP320-6RKS (RIGHT)							

Points may be ordered:

- PLAIN • HARDFACED • CHROME

Not all styles in stock.

Call Norwest Mfg. for pricing and availability.



Don't Forget!

Order Fasteners along with your Tillage Parts.

*Plow Bolts and Nuts sold separately. Tillage Parts **Do Not** come with fasteners.

See [Section 400-Plow Parts](#) for Plow Bolts & Nuts.

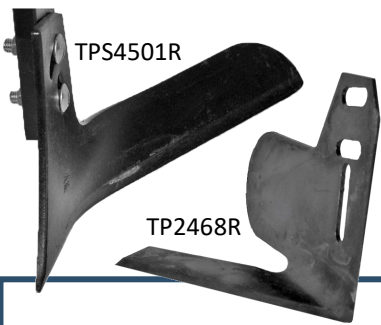

NORWEST

MANUFACTURING

71 SOUTH 215 WEST-RUPERT, ID- PHONE: (208) 436-1770 - FAX: (208) 436-1776



VEGETABLE KNIVES & HOES

VEGETABLE KNIFE & HOE STYLES (RIGHT HAND SHOWN)		
A	B	C

PART #		MATERIAL	WIDTH of CUT (A)	HOLE CENTER	BOLT SIZE	WEIGHT EACH (Approx.)	KNIFE/HOE STYLE
PLAIN						PLAIN	
CRESCENT HOES							
TIPS1016 <i>Right</i>		6 MM	6"	1-1/4" - 2"	3/8"	1.83 LBS.	A
TIPS1017 <i>Left</i>							
PLAIN	HARDFACED					PLAIN	
TENDER PLANT HOES							
TP2465R <i>Right</i>	TH2465R	1/8"	9"	2-1/2" - 3-3/4"	3/8"	2.25 LBS.	G
TP2466L <i>Left</i>	TH2466L						
IMPORTED TENDER PLANT HOES							
TIPS1122 <i>Right</i>	TIHS1122	4.75 MM	7"	1-1/4" - 2"	3/8"	2.52 LBS.	B
TIPS1123 <i>Left</i>	TIHS1123						

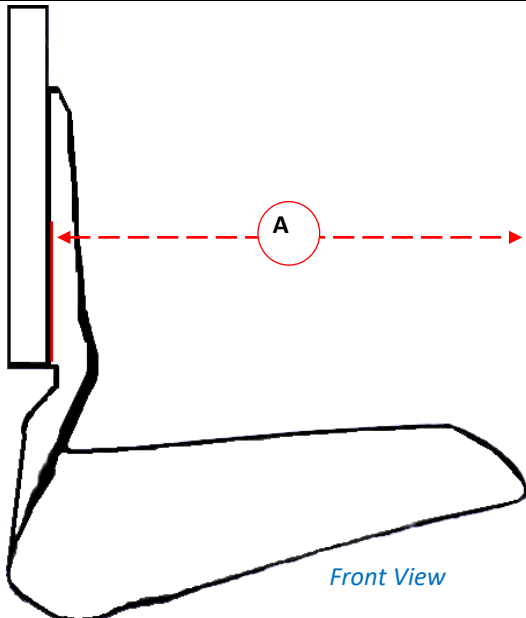

Select Knives & Hoes may be ordered:

- PLAIN
- HARDFACED

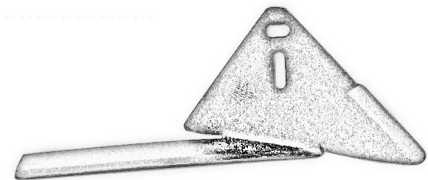

Not all styles in stock.
Call Norwest Mfg. for pricing and availability.



NORWEST













MANUFACTURING

71 SOUTH 215 WEST-RUPERT, ID- PHONE: (208) 436-1770 - FAX: (208) 436-1776





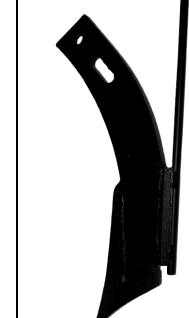

NORWEST MANUFACTURED INJECTOR KNIVES

FRONT & BACKSWEEP INJECTOR KNIFE STYLES

A	B	C	D	E	F	G	H
KP130 	KP130T 	KP132T 	KCN130T 	KCN130TC 	KCN131T 	KCN132T 	KCN170T 
I	J	K	L				
KCN150 	KCN150T 	KCN140TC 	KCN152T 				

LIQUID & DRY TUBE OPTIONS

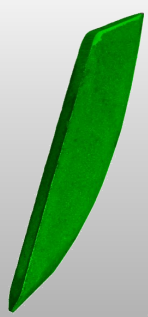
CHROME ALLOY OPTIONS

DT41007  BLACK PIPE	KCN130TS  STAINLESS TUBING	KCN132T  2" FERTILIZER TUBE	KCN131T  1-1/4" TIMIK TUBE	C13  CHROME EDGING	C20  CHROME POINT	CP13  CURVED CHROME TUBE PROTECTOR	CP15  STRAIGHT CHROME TUBE PROTECTOR
---	--	---	--	--	--	--	--

Not all styles in stock.
Call Norwest Mfg. for pricing and availability.

Select Knives may be ordered:
PLAIN • HARD FACED • CHROME



NORWEST





MANUFACTURING

71 SOUTH 215 WEST-RUPERT, ID- PHONE: (208) 436-1770 - FAX: (208) 436-1776



KCN130TC

NORWEST MANUFACTURING DRY & LIQUID BACK SWEEP INJECTOR KNIVES

STYLE	PART #			DESCRIPTION	LENGTH (A)	WEIGHT EACH (Approx.)
	PLAIN	HARDFACED	CHROME			
A	KP130 SHOWN					
						
	NORWEST MANUFACTURED BACK SWEEP INJECTOR KNIVES					
	KP130			Back Swept Knife Less Tube	13"	3.45 LBS.
		KH130		Hard Faced Back Swept Knife Less Tube	13"	3.70 LBS.
			KCN130	Back Swept Knife with C13 Chrome Edging Less Tube	13"	3.75 LBS.
		KCN170	Back Swept Knife with C13 Chrome Edging Less Tube	17"	4.25 LBS.	
B	KP130T SHOWN					
						
	KP130T			Back Swept Knife with LIQUID Tube	13"	3.65 LBS.
		KH130T		Hard Faced Back Swept Knife with LIQUID Tube	13"	3.95 LBS.
			KCN130T	Back Swept Knife with C13 Chrome edging & LIQUID Tube	13"	4.00 LBS.
			KCN130TC	Back Swept Knife with C13 Chrome Edging, LIQUID Tube & CP13 Curved Chrome Tube Protector	13"	4.50 LBS.
			KCN130TS	Back Swept Knife with C13 Chrome Edging & STAINLESS LIQUID Tube	13"	4.30 LBS.
			KCN130TCS	Back Swept Knife with C13 Chrome Edging, CP13 Curved Chrome Tube Protector & STAINLESS LIQUID Tube	13"	3.09 LBS.
		KCN 170T	Back Swept Knife with C13 Chrome Edging & LIQUID Tube	17"	4.35 LBS.	
		KCN170TC	Back Swept Knife with C13 Chrome Edging, LIQUID Tube & CP13 Curved Chrome Tube Protector	17"	4.50 LBS.	
F	KCN131T SHOWN					
						
	KP131T			Back Swept Knife with 1-1/4" TIMIK Tube	13"	4.15 LBS.
	KH131T		Hard Faced Back Swept Knife with 1-1/4" TIMIK Tube	13"	4.20 LBS.	
		KCN131T	Back Swept Knife C13 Chrome Edging & 1-1/4" TIMIK Tube	13"	4.25 LBS.	
C	KP132T SHOWN					
						
	KP132T			Back Swept Knife with 2" FERTILIZER Tube	13"	4.60 LBS.
	KH132T		Hard Faced Back Swept Knife with 2" FERTILIZER Tube	13"	4.65 LBS.	
		KCN132T	Back Swept Knife with C13 Chrome Edging & 2" FERTILIZER Tube	13"	4.70 LBS.	

**Norwest manufactured knives are made from T-1 Alloy Steel and only come in Chrome applications.*

*Not all styles in stock.
Call Norwest Mfg. for pricing and availability.*



NORWEST

MANUFACTURING

71 SOUTH 215 WEST-RUPERT, ID- PHONE: (208) 436-1770 - FAX: (208) 436-1776

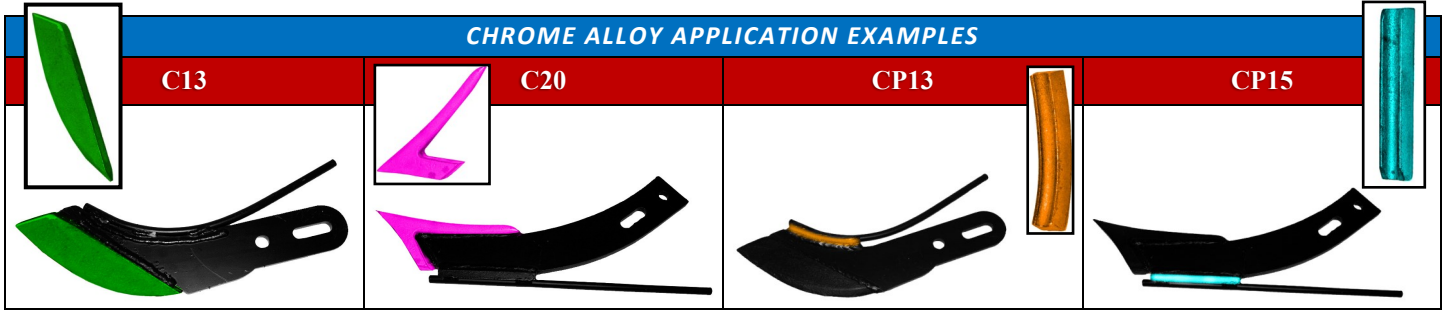

NORWEST MANUFACTURING DRY & LIQUID FRONT SWEPT INJECTOR KNIVES

PART #	DESCRIPTION	LENGTH (A)	WEIGHT EACH (Approx.)
CHROME			
NORWEST MANUFACTURED FRONT SWEPT INJECTOR KNIVES			
KCN140	Front Swept Knife with C20 Chrome Point Less Tube	15"	5.95 LBS.
KCN140T	Front Swept Knife with C20 Chrome Point & LIQUID Tube	15"	6.20 LBS.
KCN140TC	Front Swept Knife with C20 Chrome Point, LIQUID Tube & CP15 Straight Chrome Tube Protector	15"	6.45 LBS.
KCN140TS	Front Swept Knife with C20 Chrome Point, STAINLESS LIQUID Tube & CP15 Straight Chrome Tube Protector	15"	6.55 LBS.
KCN150	Front Swept Knife with C20 Chrome Point Less Tube	15"	5.50 LBS.
KCN150T	Front Swept Knife with C20 Chrome Point & LIQUID Tube	15"	5.71 LBS.
KCN150TC	Front Swept Knife with C20 Chrome Point, LIQUID Tube & CP15 Straight Chrome Tube Protector	15"	6.12 LBS.
KCN150TS	Front Swept Knife with C20 Chrome Point, STAINLESS LIQUID Tube & CP15 Straight Chrome Tube Protector	15"	6.50 LBS.
KCN142T	Front Swept Knife with C20 Chrome Point & 2" FERTILIZER Tube.	14"	6.40 LBS.
KCN152T	Front Swept Knife with C20 Chrome Point & 2" FERTILIZER Tube.	15"	6.16 LBS.

STYLE
<p>KCN140TC SHOWN</p>  <p>K</p>
<p>KCN150 SHOWN</p>  <p>I</p>
<p>KCN152T SHOWN</p>  <p>L</p>

**Norwest manufactured knives are made from T-1 Alloy Steel and only come in Chrome applications.*

*Not all styles in stock.
Call Norwest Mfg. for pricing and availability.*

NORWEST ADJUSTABLE WING HILLER

101000



The Norwest adjustable hiller can be used for both hilling row crops and corrugation. The 10" high wings are adjustable so they will press firmly against the walls of the furrow. Running the hillers in pairs allows them to press against each side of the plant row, while moving soil and firming up the hills. Norwest adjustable hillers use high carbon steel wings and a ductile main body casting for strength and long wear. The adjustable hiller can be mounted by using a Norwest 3/4" clamp (Part # 340 or 342R) and a 3/4" straight flat shank (Part # 108014). *Clamps & Standards sold Separately.*

NORWEST PART #

101000

EXPLODED VIEW

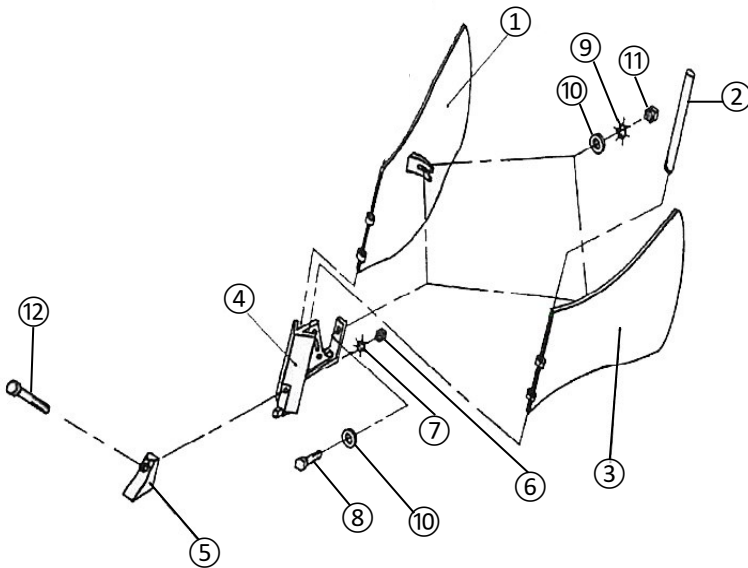

PART #	DESCRIPTION	WEIGHT EACH
101000	Adjustable Wing Hiller Assembly	38.50 LBS.
101001	101004	101005
101007	101013	

REFERENCE #	PART #	DESCRIPTION	LENGTH (A)	WEIGHT EACH (Approx.)	QUANTITY EACH
1	101001	Right Hand Adjustable Hiller Wing	10"	10.23 LBS.	1
2	101004	Hinge Pin	9.5"	0.40 LBS.	1
3	101005	Left Hand Adjustable Hiller Wing	10"	10.24 LBS.	1
4	101007	Solid Chrome Main Body Casting (Ductile)	10"	15.00 LBS.	1
5	101013	Solid Chrome Tip	5"	1.61 LBS.	1
6	FHN76	7/16" Finished Hex Nut	N/A	N/A	1
7	FLW76	7/16" Lock Washer	N/A	N/A	1
8	FHB12350G5	1/2" X 3-1/2" Grade 5 Hex Bolt	N/A	N/A	1
9	FLW12	1/2" Lock Washer	N/A	N/A	1
10	FFW12	1/2" Flat Washer	N/A	N/A	2
11	FHN12	1/2" Hex Nut	N/A	N/A	1
12	FHB76350G5	7/16" X 3-1/2" Grade 5 Hex Bolt	N/A	N/A	1

TILLAGE TOOLS for GRAINGER APPLICATIONS



Norwest Part #
G-6L



Norwest Part #
SGP-EDP20



Norwest Part #
TPGS-EDP

PART #	DESCRIPTION	DIMENSIONS	WEIGHT EACH (Approx.)
SHOVEL CORRUGATORS for GRAINGER			
G-6S	Grainger Style 6" Small Shovel Corrugator	6" Height x 24" Long	23.22 LBS.
G-6L	Grainger Style 8" Large Shovel Corrugator	8" Height x 24" Long	30.95 LBS.
SHANKS for GRAINGER			
SGP-EDP20	5/8" X 2" Shank with TPGS-EDP Point	5/8" X 2" X 31-1/2"	11.07 LBS.
CHROME POINTS for GRAINGER SHANKS			
TPGS-EDP	Solid Steel Point for Grainger Shank	3/8" X 1-5/8" x 3-1/2"	0.46 LBS.

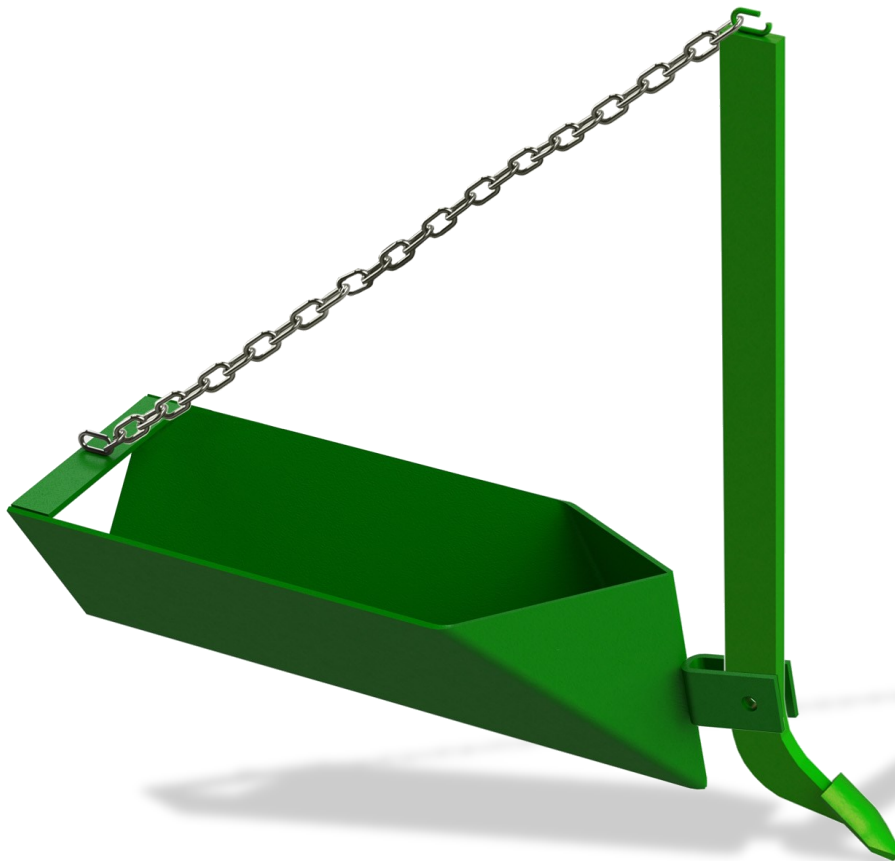

Norwest Part #'s
SGP-EDP20 Shank
shown with
G-6L Shovel Corrugator

Not all styles in stock. Call Norwest Mfg. for pricing and availability.